

Figure 1

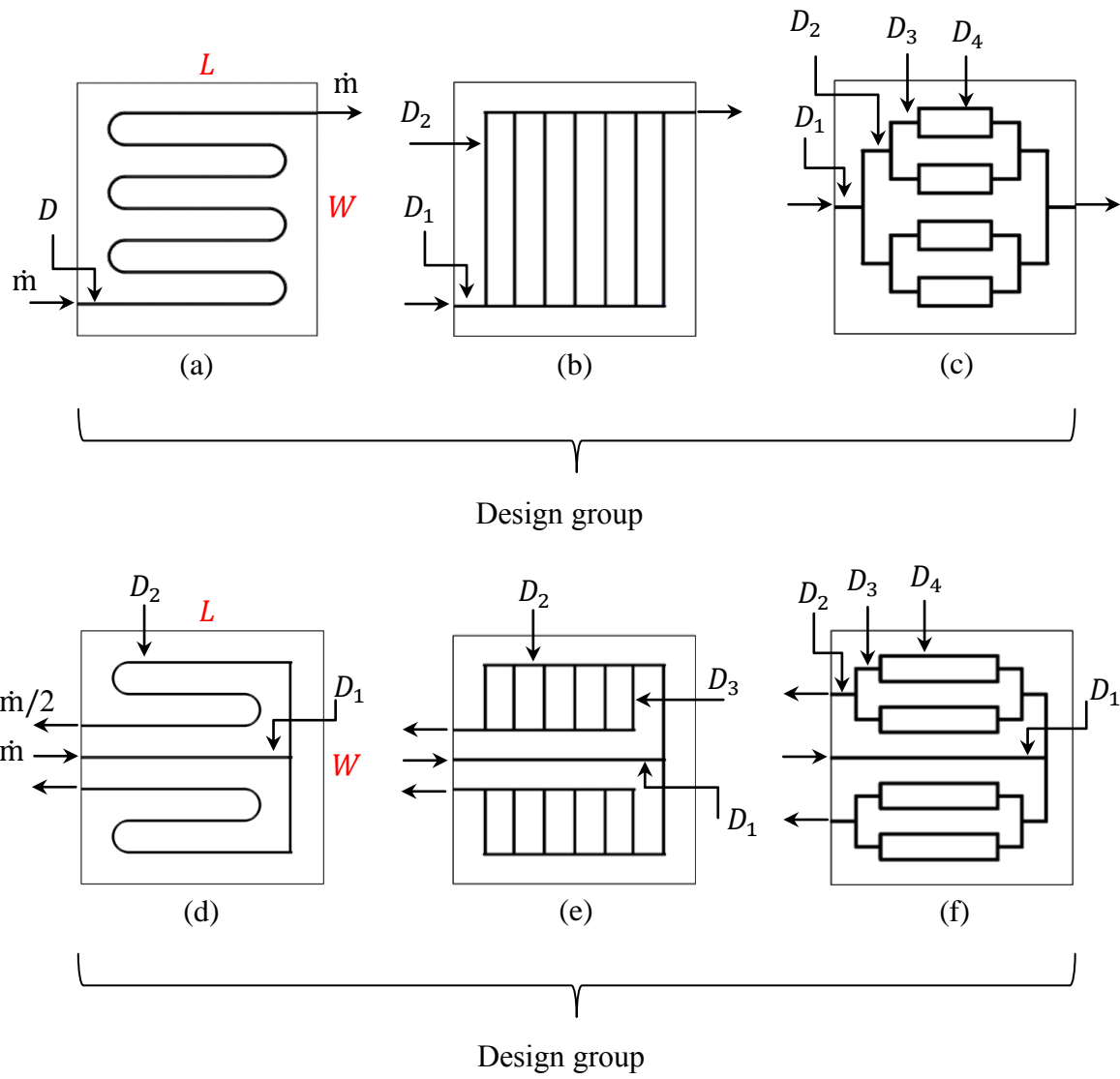
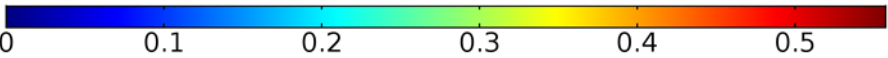

Figure 2

$$\theta_p = \frac{T_p - T_{w,in}}{T_{amb} - T_{w,in}}$$

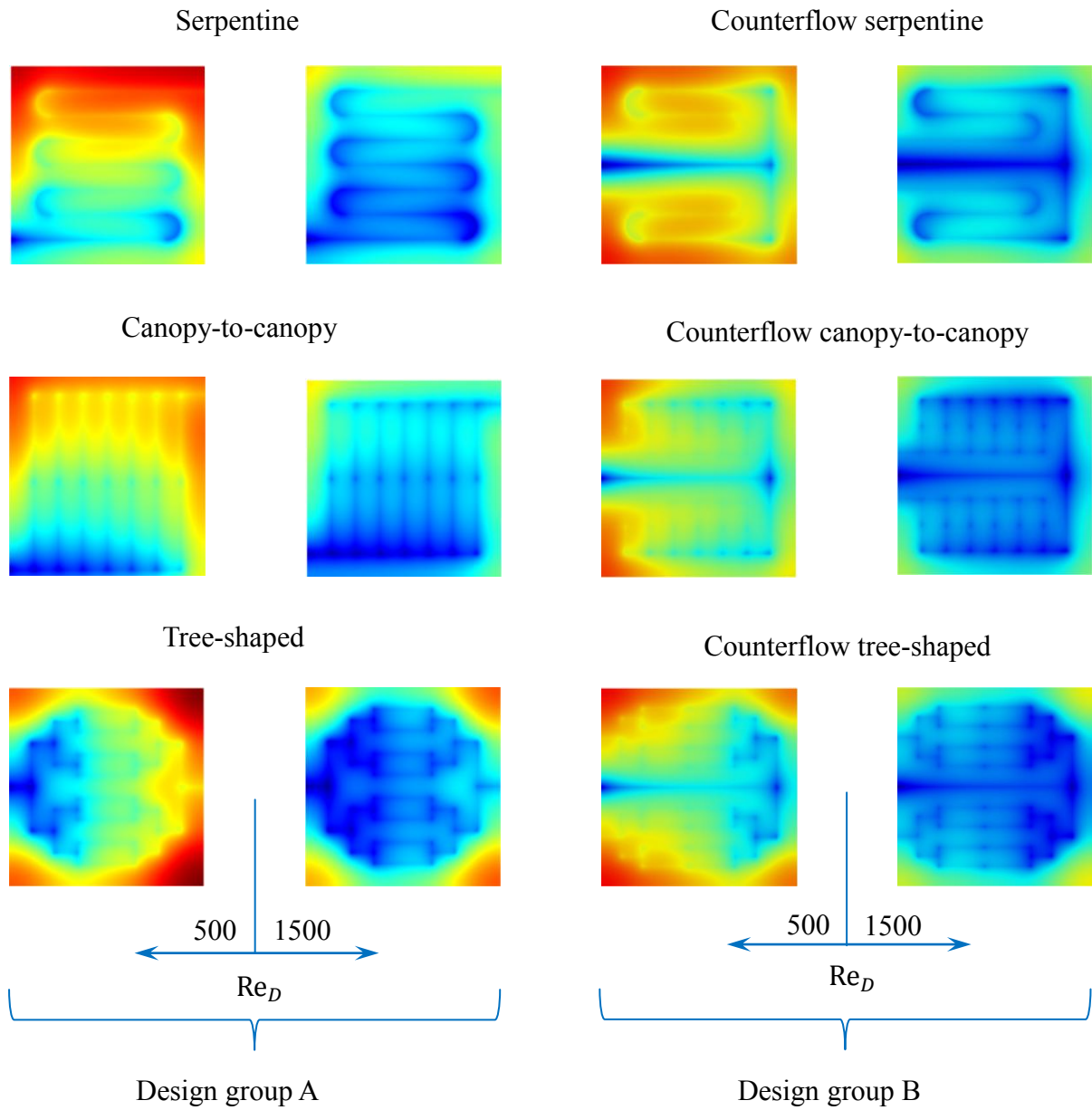
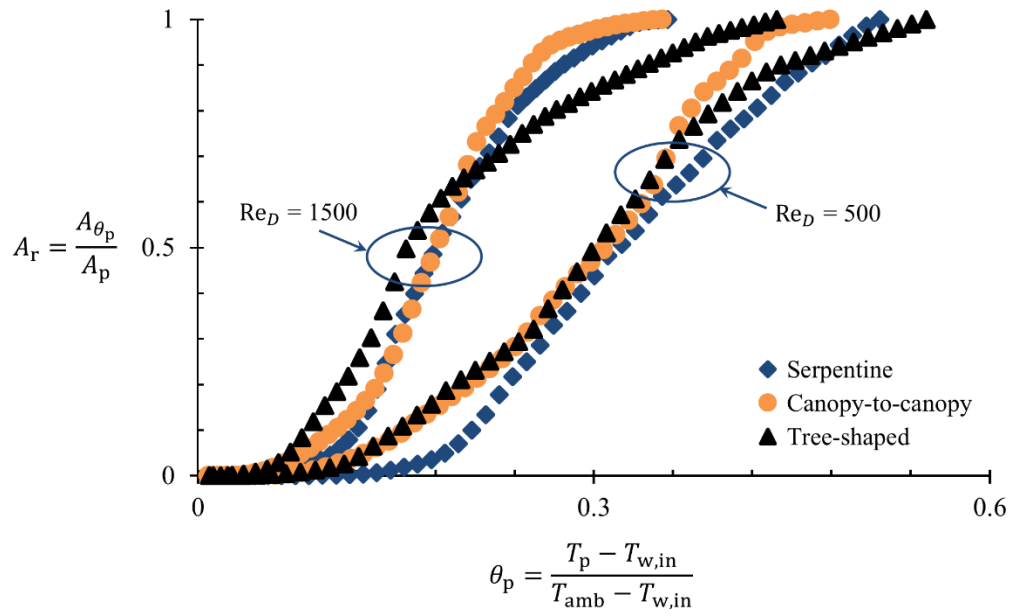
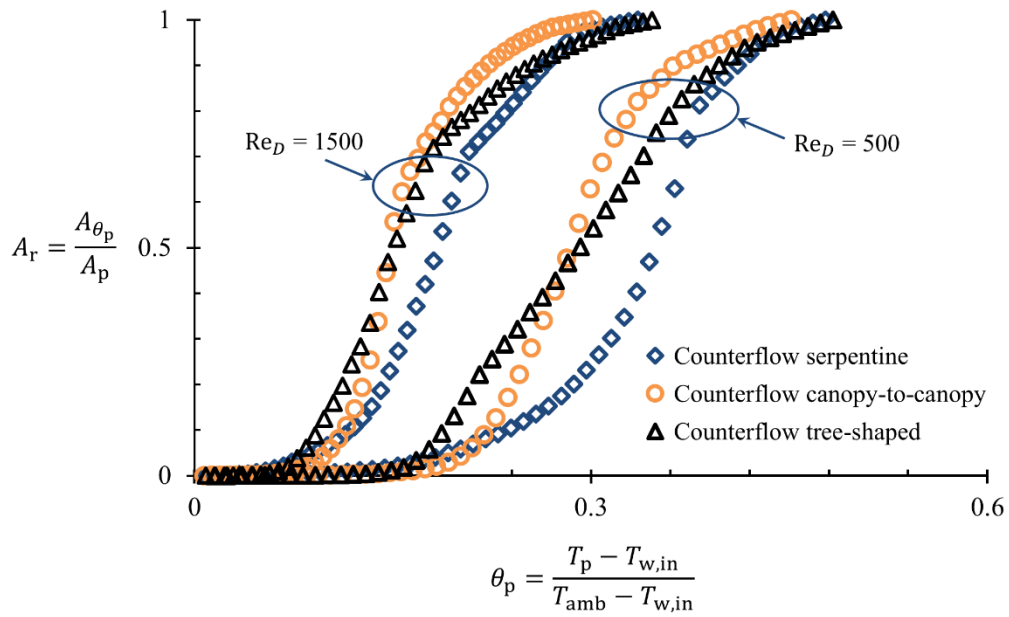

Figure 3



(a)



(b)

Figure 4

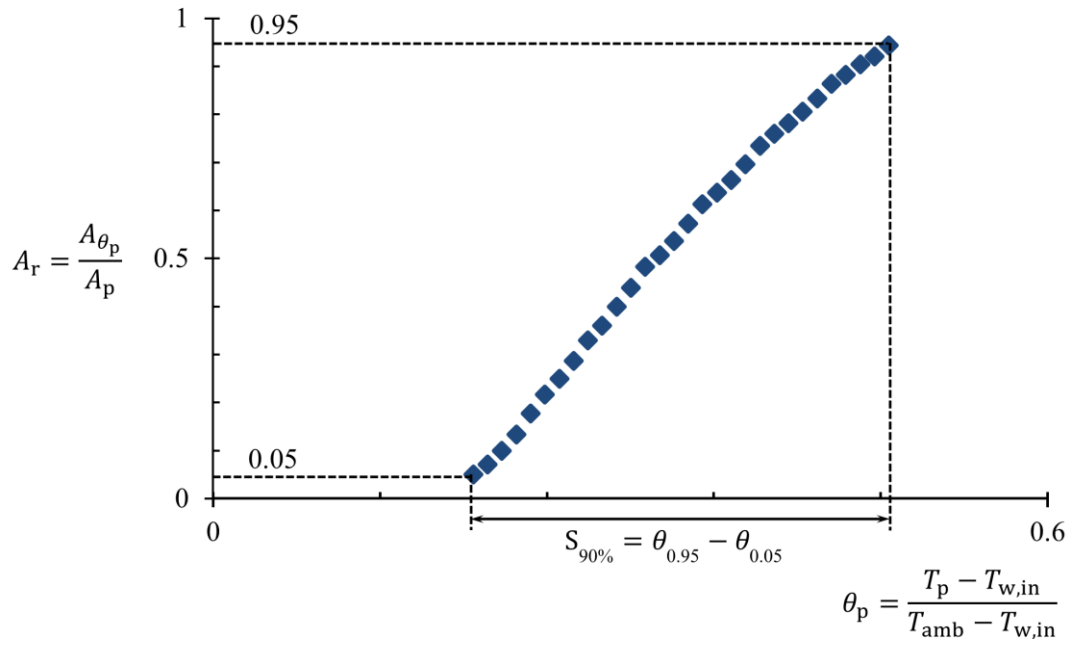

(a)

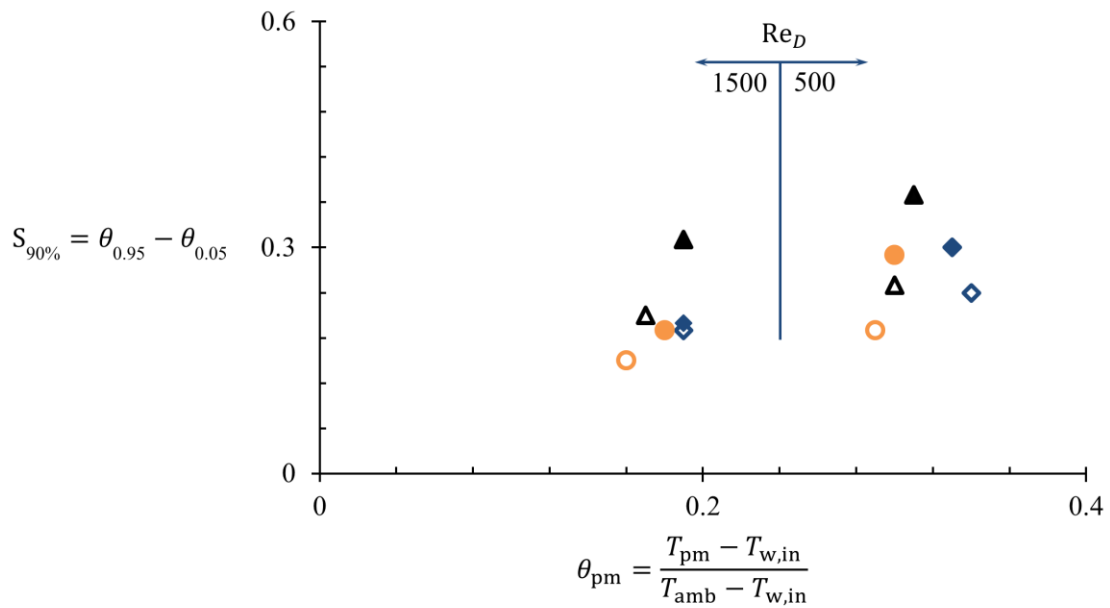

- ◆ Serpentine
- Canopy-to-canopy
- ▲ Tree-shaped
- ◇ Counterflow serpentine
- Counterflow canopy-to-canopy
- ▲ Counterflow tree-shaped

(b)

Figure (5)

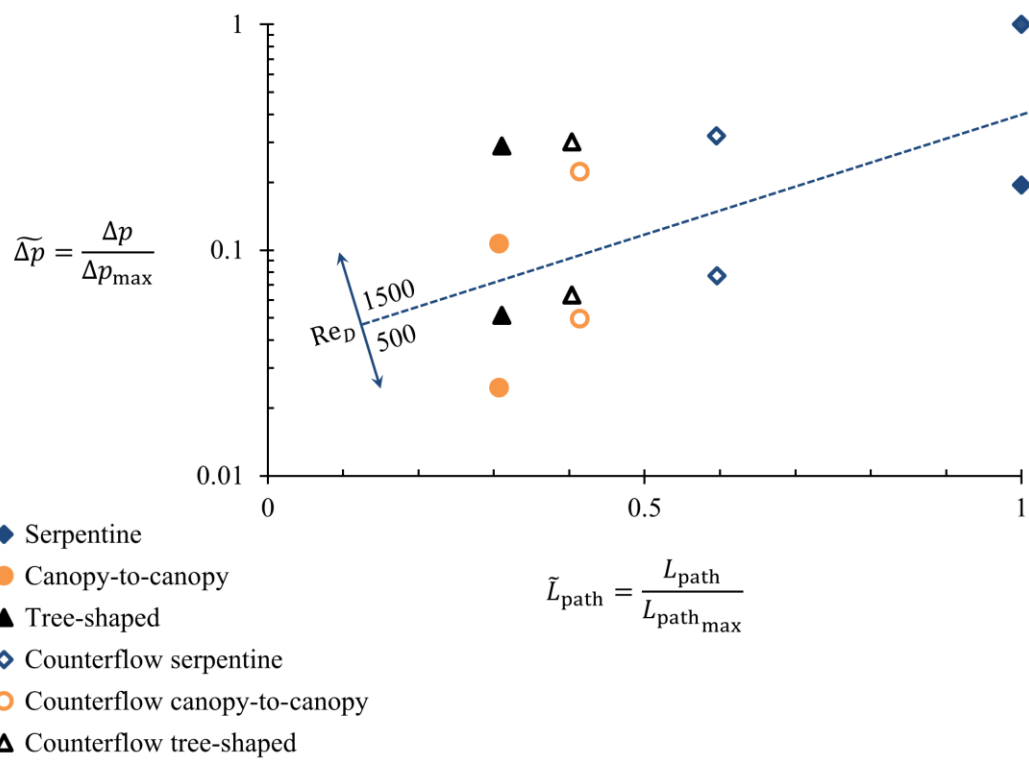

Figure 6

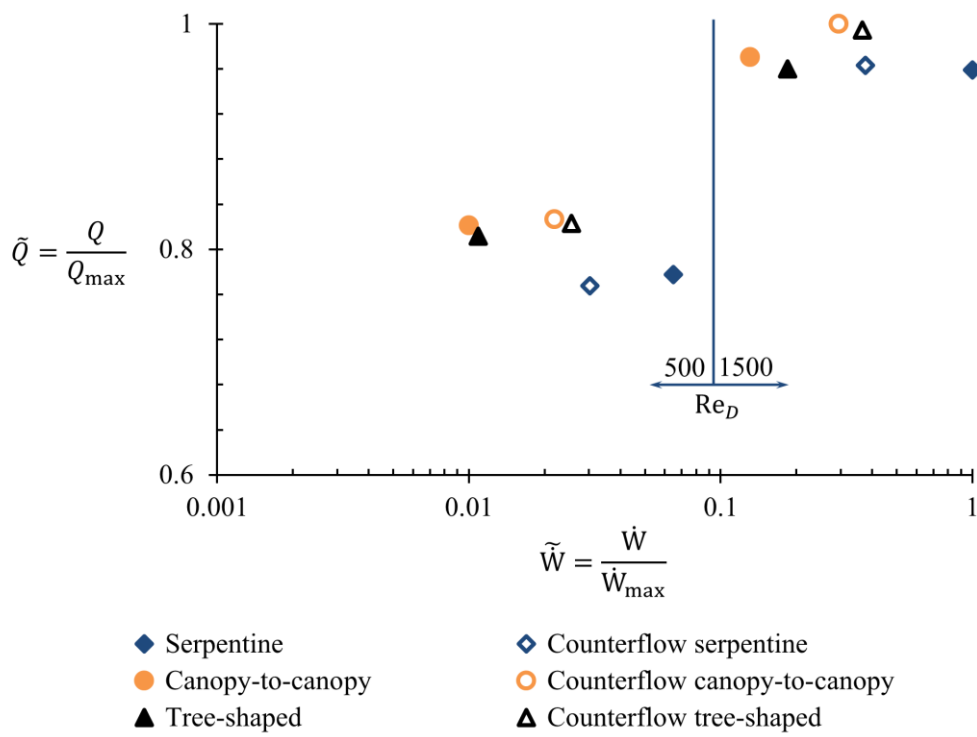

Figure 7

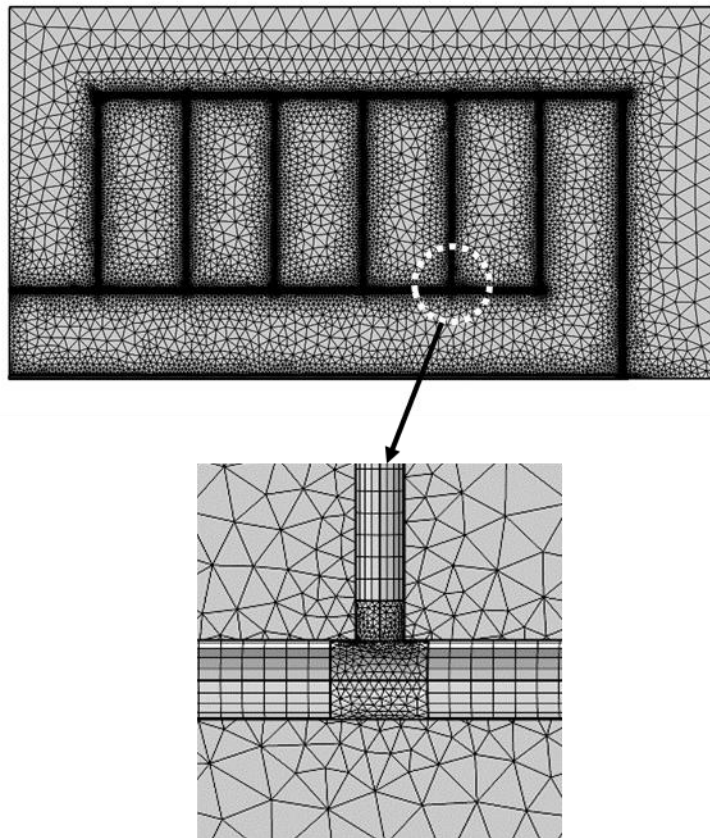
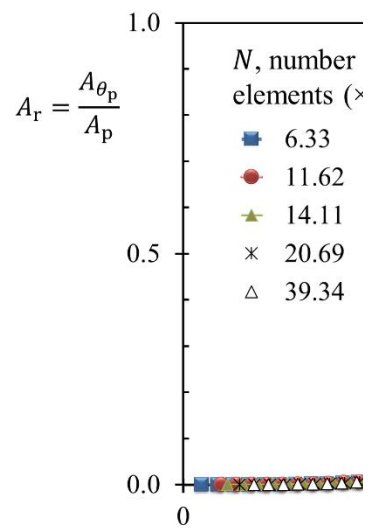
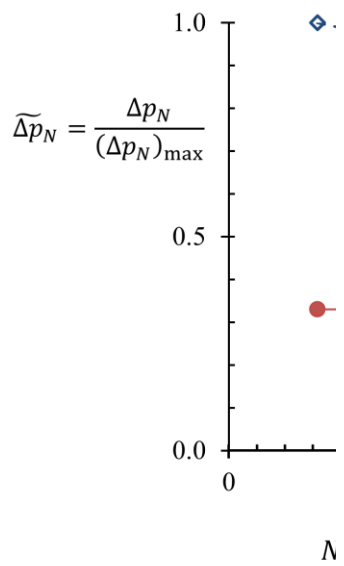

Figure A1



(a)



(b)

Figure A2

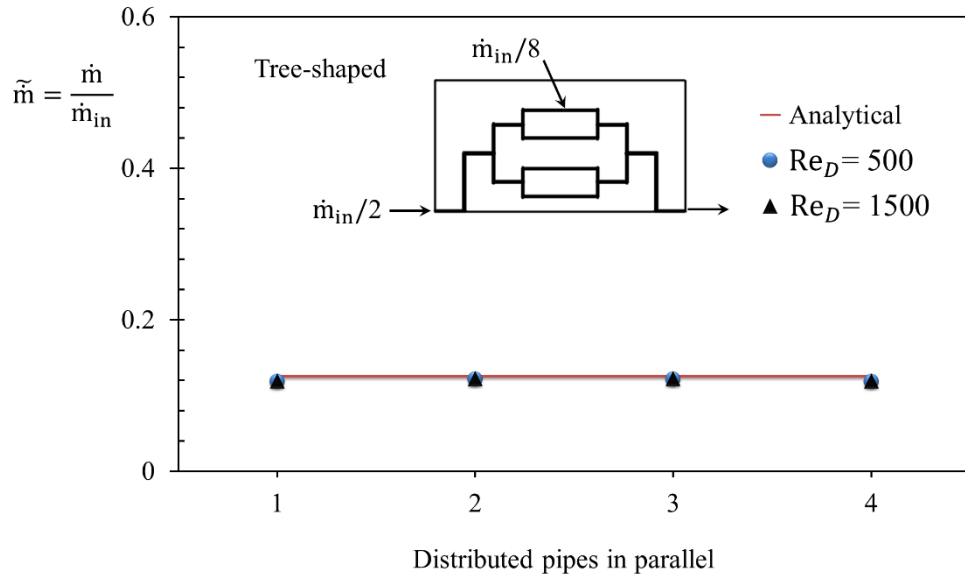

(a)

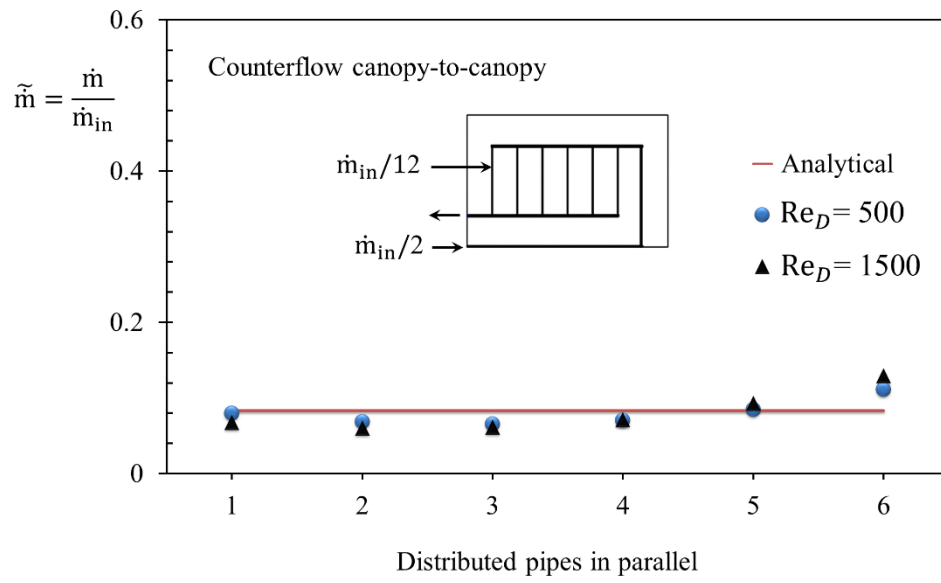

(b)

Figure C1